

ACCESSORIES FOR RESILIENT FLOORINGS

CORE ACCESSORIES

>COVE FORMERS

PVC COVE FORMER

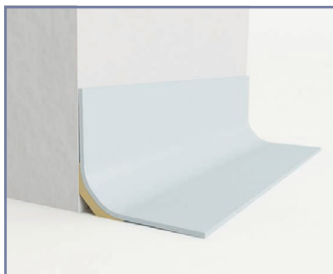

Used to form a cove where floor coverings are continued up the wall. Usually used with a capping seal or cap to finish the raw edge of the floor covering.

Delivery: 25 units of 2lm

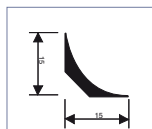

PA15 (mm)
26617 001

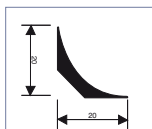

PA20 (mm)
1441 000

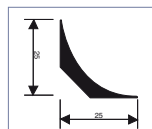

PA25 (mm)
26629 001

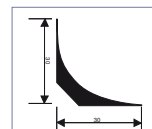

PA30 (mm)
1442 000

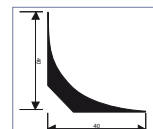

PA40 (mm)
26618 001

PVC CAPPING



Used to finish the top of a resilient floor covering where it has been covered up the wall. Usually used with a cove former.

CAP1: semi-flexible, cost-effective

CAP2: self-adhesive, easy to install

CAP3: two-parted, hygienic

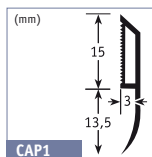

CAP1

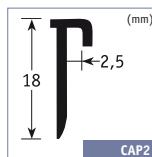

CAP2

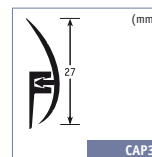

CAP3

	CAP1	CAP2	CAP3
Medium grey RAL: 5000 NCS: S 5502 B	1443 000	-	-
Light grey RAL: 7500 NCS: S 3000 N	1443 001	-	-
White RAL: 9003 NCS: S 0500 N	1443 002	1444 001	1445 001
Black RAL: 1900 NCS: S 9000 N	-	1444 000	1445 000
Silver	-	1444 002	-
Wood colour matched RAL: 070 80 30 NCS: S 2020 Y 30 R	-	-	1445 002
Delivery	25 units of 2.70lm	25 units of 2.70lm	25 units of 2.70lm

2 IN 1: COVE FORMER & CAPPING

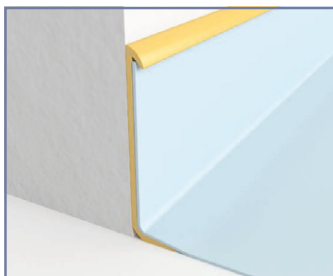

Provides a neat cove allowing floor coverings to be dressed up the wall to form a skirting, supports floor covering at a weak point, and protects the exposed edge.

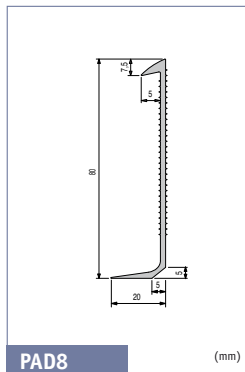

PAD8 (mm)

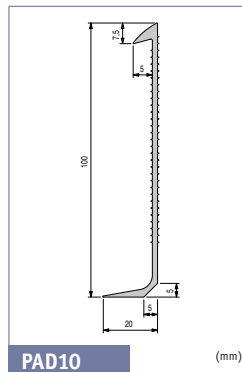

PAD10 (mm)

	PAD8	PAD10
Medium grey RAL: 5000 NCS: S 5502 B	1438 000	1437 000
Light grey RAL: 7500 NCS: S 3000 N	1438 001	1437 001
White RAL: 9003 NCS: S 0500 N	1438 002	1437 002
Delivery	20 units per box in 2lm	20 units per box in 2lm

>SET-ON SKIRTINGS

FLEXIBLE SKIRTING



Flexible PVC skirting used where a neat and clean finishing is required in non critical areas.

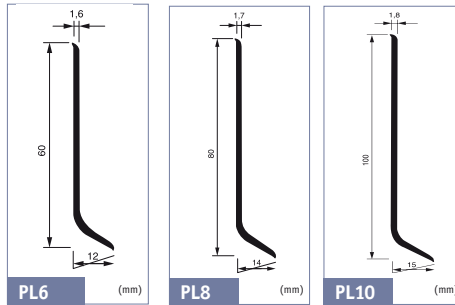

	PL6	PL8	PL10
Matched to wood RAL: 070 80 30 NCS: S 2020 Y 30 R	1449 000	1458 000	1450 000
Black RAL: 1500 NCS: S 9000 N	1449 001	1458 001	1450 001
Medium grey RAL: 5000 NCS: S 5502 B	1449 002	1458 002	1450 002
Silver grey RAL: 070 80 10 NCS: S 2005 Y 40 R	1449 003	1458 003	1450 003
Light grey RAL: 8500	1449 004	1458 004	1450 004
White RAL: 9003 NCS: S 0500 N	1449 005	1458 005	1450 005
Delivery	1 unit of 50lm	1 unit of 50lm	1 unit of 50lm

VENTILATED SKIRTING

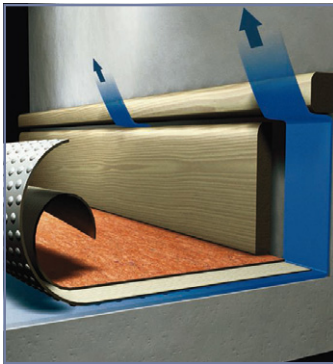

Ventilated skirting made of wood to be painted. To be used in combination with loose lay floorings or with floor coverings on Tarkolay.

Article code: 1252 030 (unfinished)

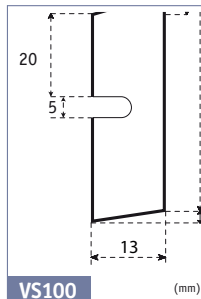

LINOLEUM SKIRTING

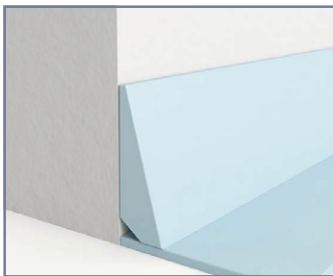

Made with an MDF support for resistance to shocks. Tailor-made following the colour of the floor.

- 6/8cm high x 220cm long
- Colour upon request

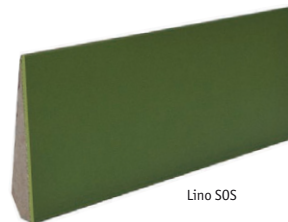

Description	Product group	Colour code
Set on skirting of 6cm for Linoleum with 2.5mm thickness	SOS 25 6cm	1736
Set on skirting of 8cm for Linoleum with 2.5mm thickness	SOS 25 8cm	1737
		To be created on request

ACCESSORIES FOR RESILIENT FLOORINGS

CORE ACCESSORIES

>SET-ON SKIRTINGS

SEMI-FLEXIBLE DECORATIVE SKIRTING

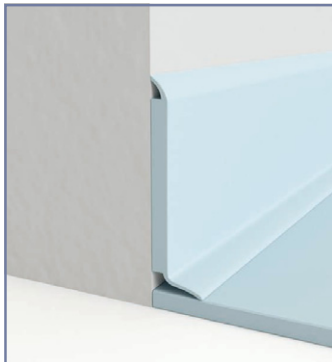

KS61 - PVC semi-rigid skirting for decorative use.

S60/S100 - Rigid skirting on a MDF support for decorative use.

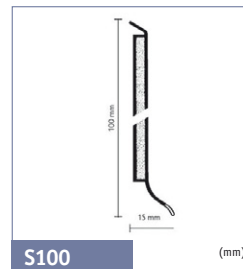
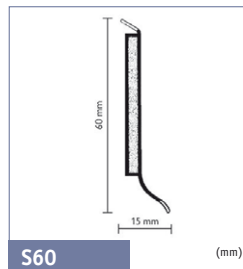
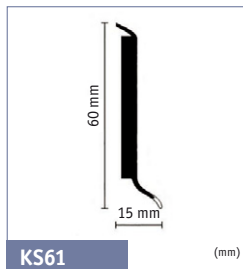

	KS61	S60	S100
Black RAL: 1500 NCS: S 9000 N	1411 007	1446 007	
Dark grey RAL: 3500 NCS: S 7502 B	1411 008	1446 008*	1447 008
Medium grey RAL: 7012 NCS: S 5502 B	1411 009**	1446 009	1447 009*
Grey RAL: 6000 NCS: S 4000 N	1411 010	1446 010*	1447 010
Light grey RAL: 7500 NCS: S 3000 N	1411 011**	1446 011	1447 011*
Very light grey RAL: 8500 NCS: S 1500 N	1411 012**	1446 012*	1447 012
Dark brown RAL: 060 40 05 NCS: S 7005 Y 50 R	1411 013**	1446 013	1447 013*
Dark red brown RAL: 050 20 16 NCS: S 8010 Y 70 R	1411 014	1446 014*	
Dark yellow brown RAL: 060 30 27 NCS: S 7020 Y 40 R	1411 015	1446 015	
Red brown RAL: 040 40 30 NCS: S 4040 Y 70 R	1411 016	1446 016*	
Terracotta RAL: 050 30 30 NCS: S 6030 Y 70 R	1411 017	1446 017	
Dark red RAL: 040 30 40 NCS: S 3560 Y 80 R	1411 018**	1446 018*	
Red RAL: 030 40 60 NCS: S 1580 Y 90 R	1411 019	1446 019	
Orange RAL: 050 60 60 NCS: S 0570 Y 50 R	1411 020	1446 020*	
Beige RAL: 070 60 20 NCS: S 4020 Y 20 R	1411 021	1446 021	
Medium brown RAL: 060 40 30 NCS: S 5030 Y 40 R	1411 022	1446 022*	1447 022
Brown RAL: 060 50 30 NCS: S 4030 Y 30 R	1411 023	1446 023	
Light brown RAL: 060 60 30 NCS: S 3030 Y 40 R	1411 024	1446 024*	
Medium beige RAL: 070 80 30 NCS: S 2020 Y 30 R	1411 025	1446 025	1447 025*
Delivery	20 units of 2.50lm	20 units of 2.57lm	10 units of 2.57lm

	KS61	S60	S100
Grege RAL: 070 80 10 NCS: S 1500 N	1411 026	1446 026*	1447 026
Light beige RAL: 080 80 20 NCS: S 2010 Y 20 R	1411 027	1446 027	
Yellow RAL: 070 70 60 NCS: S 1060 Y 20 R	1411 028	1446 028*	
Purple red RAL: 340 50 20 NCS: S 4030 R 30 B	1411 029	1446 029	
Purple blue RAL: 290 60 25 NCS: S 2040 R 60 B	1411 030	1446 030*	
Light purple RAL: 290 60 10 NCS: S 3020 R 60 B	1411 031	1446 031	
Rose wood RAL: 060 60 10 NCS: S 3010 Y 50 R	1411 032	1446 032*	
Light green RAL: 120 70 30 NCS: S 2030 G 40 Y	1411 033	1446 033	
Medium green RAL: 110 60 20 NCS: S 3020 G 40 Y	1411 034	1446 034*	
Blue green RAL: 190 60 10 NCS: S 3020 B 50 G	1411 035	1446 035	
Green yellow RAL: 100 70 60 NCS: S 2050 G 70 Y	1411 036	1446 036*	
Night blue RAL: 250 30 10 NCS: S 7010 R 90 B	1411 037**	1446 037	
Navy blue RAL: 250 50 25 NCS: S 3040 R 90 B	1411 038	1446 038*	
Dark blue RAL: 270 40 25 NCS: S 5030 R 80 B	1411 039	1446 039	
Blue RAL: 260 60 25 NCS: S 2040 R 80 B	1411 040	1446 040*	
Medium blue RAL: 250 50 20 NCS: S 4030 R 90 B	1411 041	1446 041	
Sky blue RAL: 230 70 15 NCS: S 2020 B	1411 042	1446 042*	
Light blue RAL: 260 70 15 NCS: S 2020 R 80 B	1411 043	1446 043	
Green blue RAL: 200 60 20 NCS: S 3030 B 50 G	1411 044	1446 044*	
Delivery	20 units of 2.50lm	20 units of 2.57lm	10 units of 2.57lm



Specific cutting tool for corners recommended for S60 and S100.

* On request.

** 6 colours available in self adhesive skirtings.

Medium grey 1461 009	Dark brown 1461 013
Light grey 1461 011	Dark red 1461 018
Very light grey 1461 012	Night blue 1461 037

>SET-ON SKIRTINGS

RIGID DECORATIVE SKIRTING WITH MATERIAL TO BE INSERTED



IS60/ISS60 - Rigid skirtings made on MDF support.

Floor covering to be inserted for perfect colour matching. To be glued.

ISS60 - Specially developed for LVT.

		IS60
	Medium grey	
	RAL: 5000	1448 000
	NCS: S 5502 B	
	Light grey	
	RAL: 7500	1448 001
	NCS: S 3000 N	
	White	
	RAL: 9003	1448 002
	NCS: S 0500 N	
Delivery		20 units of 2.57lm

		ISS60
	black	1462001
	silver grey	1462002
	white	1462003
	chocolate	1462004
	light beige	1462005
	cappuccino	1462006
Delivery		20 pieces in one cardboard box = 51.40lm

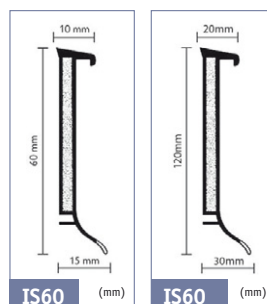

FLEXIBLE DECORATIVE SKIRTING WITH MATERIAL TO BE INSERTED

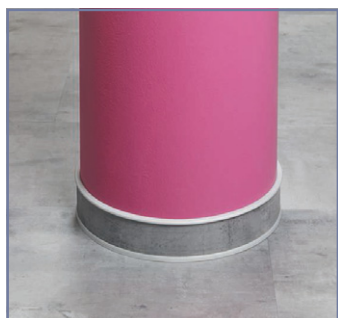

Very flexible skirting for curved walls and pillars. Floor covering to be inserted for perfect colour matching. Self adhesive both sides: 7 x 60 x 2500mm.

Ordering unit: 1 box of 10 = 25lm.



1464 001

Clip Cutter

Designed to facilitate the cutting of the floor covering to be inserted in the above skirtings.

		ISF 60
	White	1463007
	Silver grey	1463002
	Steel	1463003

WHITE SKIRTING FOR LVT

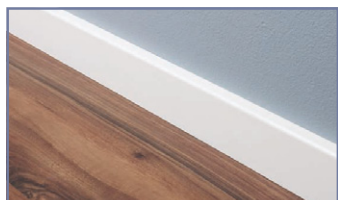

Veneer real wood skirting board.

Article	Article code	Color	
16x60x2400mm	8791 740		White
Clip holder	8791 800	-	

Clip Holder

Replace adhesive to hold large skirtings in place: easy installation & removal.



ADJUSTABLE WHITE SKIRTING FOR LVT



Used for renovation to encapsulate existing ceramic wall bases.

Article	Article code	Color	
16x130x2200mm	8301 555		White
Clip holder	For large skirtings	8019 101	-
	For white skirtings	8791 800	-

ACCESSORIES FOR RESILIENT FLOORINGS

CORE ACCESSORIES

>SET-ON SKIRTINGS FOR LVT

LVT PVC SKIRTING



- compact PVC skirting with decorative film and **PUR treatment**, to be glued
- **easy maintenance** with water-resistant material
- perfect finishing with **matching colours** for:
 - 22 references of **iD Inspiration Click & Inspiration**
 - all references of **iD Inspiration Loose-lay**
 - **TILT** Concrete references
 - 22 references of **iD Essential**

Size: 60 mm high x 10 mm thick x 2020 mm long

Packaging: 16 pieces in one box = 32,32 lm

iD Inspiration & iD Inspiration Click	
Flooring Reference	Coordinated LVT skirtings
Antik Oak-Beige	26640001
Antik Oak-Brown	26640002
Antik Oak-Dark Grey	26640003
Antik Oak-Natural	26640005
Brushed Pine-Brown	26640013
Brushed Pine-Grey	26640014
English Oak-Beige	26640024
English Oak-Brown	26640025
English Oak-Light	26640026
English Oak-Natural	26640027
Modern Oak-Grey	26640043
Modern Oak-Light	26640044
Modern Oak-Natural	26640045
Natural Walnut-Classic	26640050
Natural Walnut-Yellow	26640051
Oak-Natural	26640052
Soft Walnut-Brown	26640074
Soft Walnut-Natural	26640076
Vintage Teak-Grey	26640092
Vintage Teak-Natural	26640093
White Oak-Grey	26640101
White Oak-Light	26640102

iD Inspiration Loose-lay	
Flooring Reference	Coordinated LVT skirtings
Limed Oak - Beige	26640250
Limed Oak - Grey	26640251
Limed Oak - Brown	26640252
Mountain Oak - Natural	26640249
Mountain Oak - Brown	26640248
Mountain Oak - Black	26640247
Christmas Pine- White	26640246
Christmas Pine - Natural	26640245
Christmas Pine - Brown	26640244
Beton - White	26640240
Beton - Black	26640241
Beton - Grey	26640239
Beach Wood - Beige	26640253
Beach Wood - Grey	26640254
Delicate Wood - White	26640258
Delicate Wood - Grege	26640260
Delicate Wood - Black	26640259
Elegant Oak - Beige	26640243
Elegant Oak - Natural	26640242
Sawn Oak - Grey	26640255
Sawn Oak - Brown	26640256
Sawn Oak - Dark Brown	26640257

iD TILT	
Flooring Reference	Coordinated LVT skirtings
White	26640500
Aluminium	26640501

iD Essential	
Flooring Reference	Coordinated LVT skirtings
Smoked Oak - Brown	24640212
Smoked Oak - Dark Grey	24640211
Smoked Oak - Light Grey	24640210
Soft Oak - Brown	24640218
Soft Oak - Natural	24640215
Soft Oak - beige	24640217
Soft Oak - Light Grey	24640219
Soft Oak - Light Brown	24640218
Soft Oak - Light Brown	24640216
Colored Pine - Grey	26640201
Country Oak - Beige	24640238
Country Oak - Natural	24640237
Country Oak - Grey	24640236
Washed Pine - White	24640206
Washed Pine - Beige	24640204
Washed Pine - Light Brown	24640205
Washed Pine - Snow	24640202
Washed Pine - Blue	24640203
Cerused Oak - Beige	24640207
Cerused Oak - Light brown	24640209
Cerused Oak - brown	24640208
Venezia - Grey	24640224

>SET-IN SKIRTINGS

PREFORMED SKIRTING - PVC / LINO

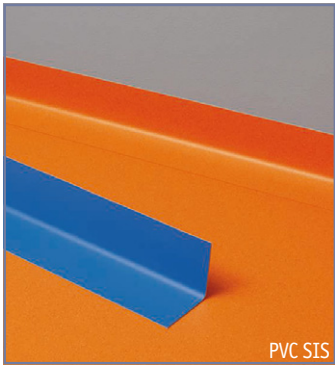

Preformed set-in skirting made of PVC or Linoleum flooring, reinforced with polymere on backside. Welded to the floor covering and glued to the wall. Ensure easy to clean and hygenic result.

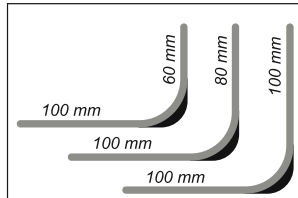

PVC

60/80/100x100x2400mm, available on request with all colours
Ordering unit: 1 box of 10 pcs = 48lm (min order 2 boxes)

Art codes:	Acoustic	100x100mm:	26611
		100x80mm:	26612
		100x60mm:	26613
Compact	100x100mm:	26614	
	100x80mm:	26615	
	100x60mm:	26616	

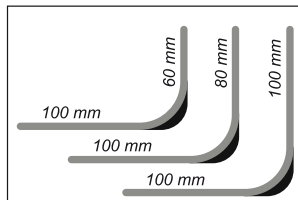
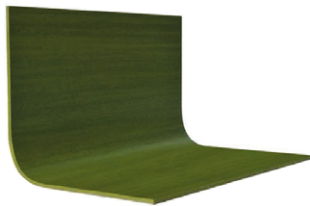

LINOLEUM

60/80/100x100x2400mm, available on request with all colours
Ordering unit: 1 box of 10 pcs = 48lm (min order 2 boxes)

	Compact 2mm	Compact 2.5mm	Acoustic 3.8mm
100x100mm:	1746	1743	1719
100x80mm:	1747	1744	1741
100x60mm:	1748	1745	1742

Exists also in 20 cm wide, onto the floor

PREFORMED OUTER CORNER - PVC / LINO

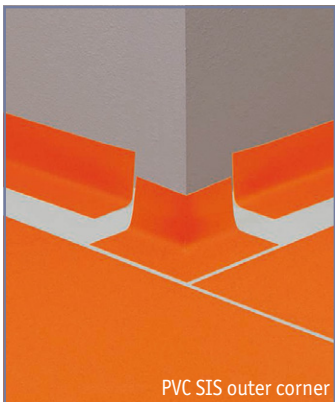

Preformed outside corner made of PVC or Linoleum flooring, reinforced with polymere on backside. Welded to the floor covering and glued to the wall. Shock resistant & watertight.

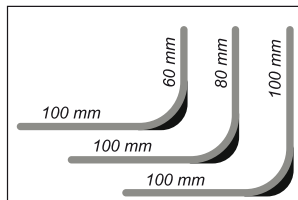

PVC

Shock resistant & watertight outside corner made of Evolution flooring, Polymere reinforced structure.

To be glued or welded.

60/80/100x100x130mm, available on request with all colours
Ordering unit: 1 box of 10 pcs

Art codes:	Acoustic	100x100mm:	26605
		100x80mm:	26606
		100x60mm:	26607
Compact	100x100mm:	26608	
	100x80mm:	26609	
	100x60mm:	26610	

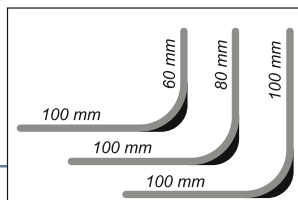
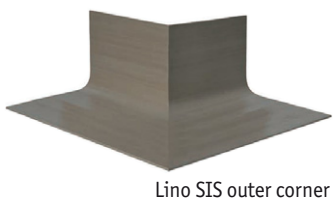

LINOLEUM

60/80/100x100mm (size of the corner 13x13cm)

	Compact 2mm	Compact 2.5mm	Acoustic 3.8mm
100x100mm:	1766	1763	1760
100x80mm:	1767	1764	1761
100x60mm:	1768	1765	1762

Exists also in 20 cm wide, onto the floor

ACCESSORIES FOR RESILIENT FLOORINGS

CORE ACCESSORIES

>PROFILES FOR ROLLS

TRANSITION PROFILE



One piece transition strip used to join different floorings of the same or slightly different heights. To be glued.

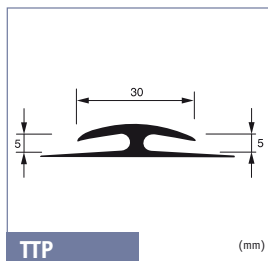

TTP	
Dark grey RAL: 5000 NCS: S 5502 B	1452 000
Light grey RAL: 7500 NCS: S 3000 N	1452 001
White RAL: 9003 NCS: S 0500 N	1452 002
Delivery	2 units of 25lm

ALUMINIUM TRANSITION PROFILE



Aluminium transition strip used to join different flooring materials. Suitable for use in heavy traffic environments. To be screwed. Typically used at door thresholds.

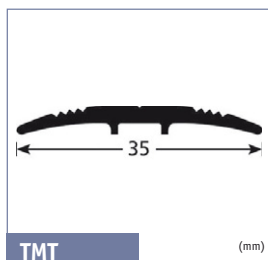

TMT	
Silver	1451 000
Bronze	1451 001
Delivery	10 units of 2.70lm

SELF-ADHESIVE TRANSITION PROFILE



Self-adhesive aluminium transition strip, for a perfect transition between different flooring materials. Suitable for use in heavy traffic areas.



MT40SA	
Silver	1470 008
Bronze	-
Delivery	10 units of 2.70lm

>PROFILES

METALLIC RAMP PROFILE



Metallic floor trim providing a neat and simple solution to join floor coverings with medium difference in thickness. To be screwed.

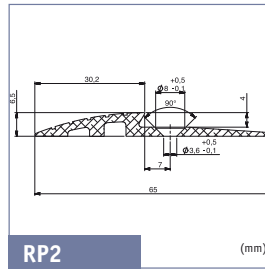
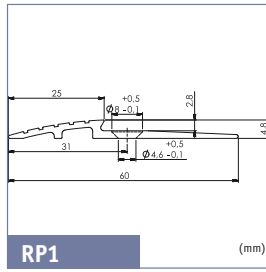

Silver	RP1	RP2
	1453 001	1454 001
Delivery	10 units of 3lm	10 units of 3lm

METALLIC RAMP PROFILE



Metallic floor trim providing a neat and simple solution to join floor coverings with major difference in thickness. To be screwed.

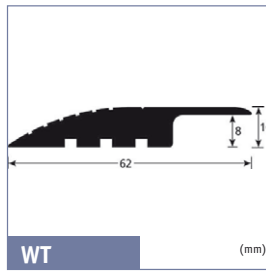

Silver	WT
	1455 000
Delivery	5 units of 3lm

FLEXIBLE RAMP PROFILE

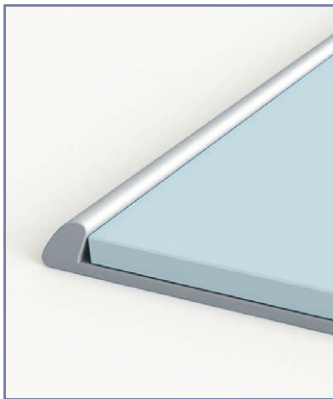

Bendable aluminium profiles used to form a join between different types of floor coverings. Can be manually curved on site to accommodate shaped and radius designs. Two heights available: one for compact floors (FT 2.5) and one for acoustic floors (FT 5). To be glued.

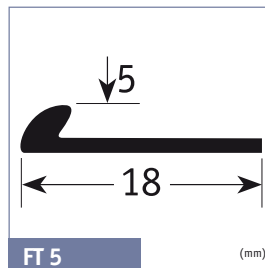
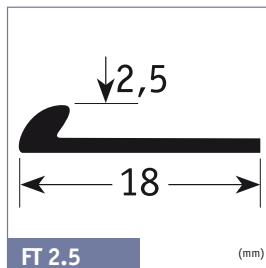

Silver	FT 2.5mm	FT 5.0mm
	1456 000	1456 001
Delivery	10 units of 2.5lm	10 units of 2.5lm

ACCESSORIES FOR RESILIENT FLOORINGS

CORE ACCESSORIES

>PROFILES FOR LVT

LVT TRANSITION STRIP VERY HIGH TRAFFIC

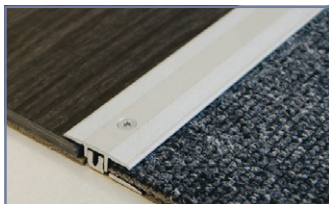

Aluminium transition strip for LVT in very high traffic.

- To be screwed.
- Very resistant to very high traffic & rolling loads.
- Ribbed surface for slip-resistance.

Size: 25 mm wide x 4/9.5 mm high x 2700 mm long

Packaging: Full kit including Bottom & Top profiles with screws: 10 units of 2,7lm in a cardboard box = 27 lm

SAP code: 1451011: silver
1451012: stainless steel

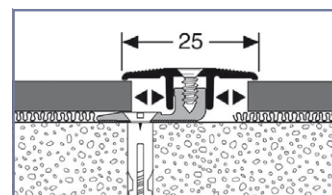
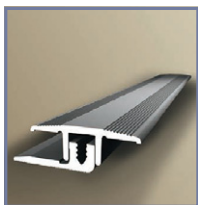

LVT TRANSITION STRIP GENERAL TRAFFIC



Aluminium transition strip for LVT used in general traffic areas.

- To be screwed.
- Elegant finish with smooth surface and no visual screws.
- Bendable with radius 60 cm.

Size: 24 mm wide x 6 mm high x 2700 mm long

Packaging: Full kit including top profiles and dowls.
10 units of 2,7lm in a cardboard box = 27 lm

SAP code: 1451021: silver
1451022: stainless steel

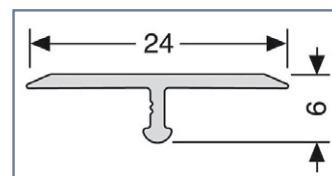
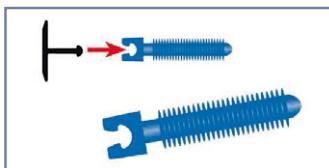

LVT RAMP PROFILE VERY HIGH TRAFFIC



Aluminium transition strip for LVT used in very heavy traffic areas.

- To be screwed.
- Very resistant to very high traffic & rolling loads – with long ramp to ease transfers.
- Ribbed surface for slip-resistance.

Size: 38 mm wide x 5/7 mm high x 2700 mm long

Packaging: Kit including ramp profile and screws. 10 units of 2,7lm in a cardboard box = 27 lm

SAP code: 1454011: silver
1454012: stainless steel

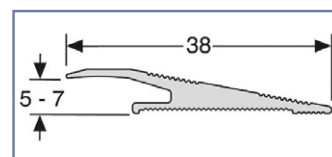
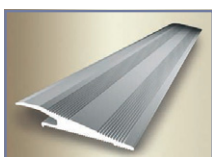

>PROFILES FOR LVT

LVT BENDABLE STOP PROFILE



Aluminium stop profile to be screwed.

- Very resistant to wear & traffic
- Ribbed surface for slip-resistance
- Bendable with radius 80cm

Size: 30 mm wide x 5 mm high inside x 8 mm high outside 30 mm high x 2500 mm long
Packaging: Full kit including stop profiles, screws and dowels. 10 units of 2,5lm in a cardboard box = 25 lm

SAP code: 1456011: silver
1456012: stainless steel

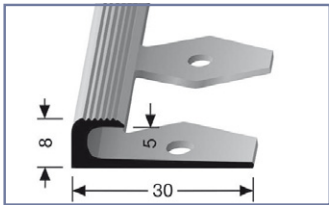

LVT SKIRTING BOTTOM

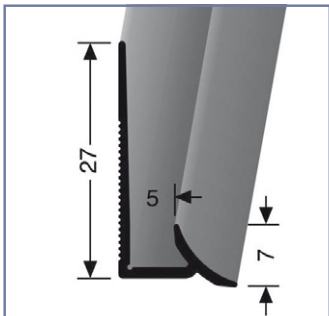

Aluminium skirting bottom for LVT, to be combined with the cap for skirting. To be glued.

- Real material to be inserted
- Elegant finish with 100 % color matching with floor covering
- Also compatible for perfect finish in stairs

Size: 5 mm inside x 27 mm high x 7 mm lower lip x 2500 mm long

Packaging: 10 units of 2,5lm in a cardboard box = 25 lm

SAP code: 26626021: silver
26626022: stainless steel

LVT SKIRTING CAP



Aluminium skirting cap for LVT to be combined with skirting bottom.

- To be glued.
- Perfect protection of the edge of the product
- Elegant finish

Size: 20 mm wide x 6 mm high inside x 8.5 mm high outside x 2500 mm long

Packaging: 10 units of 2,5lm in a cardboard box ie 25 lm

SAP code: 26626011: silver
26626012: stainless steel

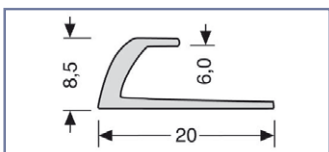

ACCESSORIES FOR RESILIENT FLOORINGS

CORE ACCESSORIES

>STAIRS ACCESSORIES

PVC STAIRNOSE



Flexible PVC stairnose. Cut to size on site and fixed with adhesive before floor covering. Typically used with resilient floor coverings.

NM1: specially designed for round-shaped stair noses, with bending radius 8R.

NM20: designed for slight round-shaped stair noses in housing, with bending radius 4R.

NM45: designed for sharp-angled stair noses, with bending radius 2R, for stairs over 16cm high.

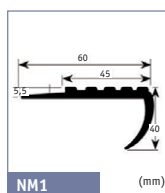

NM1 (mm)

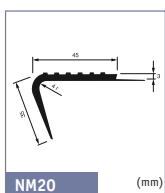

NM20 (mm)

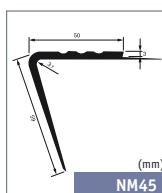

NM45 (mm)

	NM1	NM20	NM45
Black RAL: 1500 NCS: S 9000 N	1401 004	1404 004	1403 004
Medium grey RAL: 5000 NCS: S 5502 B	1401 005	1404 005	1403 005
Light grey RAL: 7500 NCS: S 3000 N	1401 006	1404 006	1403 006
Silver grey RAL: 8500	1401 007	1404 007	1403 007
Delivery	12 units of 3lm	12 units of 3lm	12 units of 3lm

ALUMINIUM STAIRNOSE



Aluminium stairnose. To be screwed over the floor covering.

	MS1
Silver	1434 001
Delivery	10 units of 2,6lm

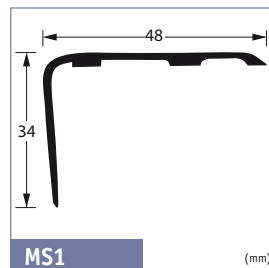

MS1 (mm)

SELF ADHESIVE ALUMINIUM STAIRNOSE



Self-adhesive aluminium stairnose, protects the floor and helps enhance safety.

	MSN24A
Silver	1480 008
Delivery	10 units of 2,7lm

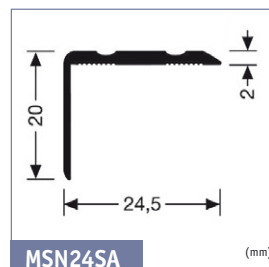

MSN24SA (mm)

>STAIRS ACCESSORIES

INSIDE & OUTSIDE STAIR CORNER

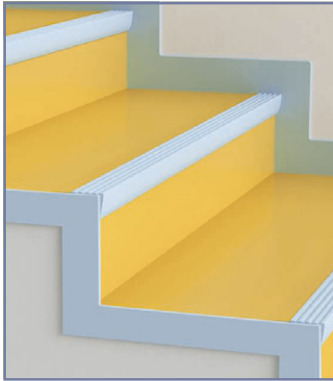

Corners designed to form a neat and attractive edge around the open end of a step by concealing the edge of the floor covering and stair edging. Colour combination with PVC stair nosing.

- SB1:** used to protect the bottom of the wall alongside the staircase
- SB2:** used to protect the edge of the floor covering and to hide it

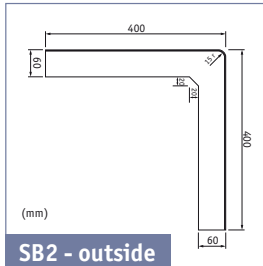
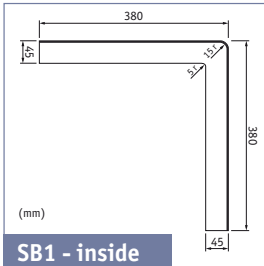

	SB1 interior	SB2 exterior
Black RAL: 1500 NCS: S 9000 N	1432 004	1433 004
Medium grey RAL: 5000 NCS: S 5502 B	1432 005	1433 005
Light grey RAL: 7500 NCS: S 3000 N	1432 006	1433 006
Silver grey RAL: 8500	1432 007	1433 007
Delivery	20 units per box	20 units per box

LVT STAIRNOSE HIGH TRAFFIC

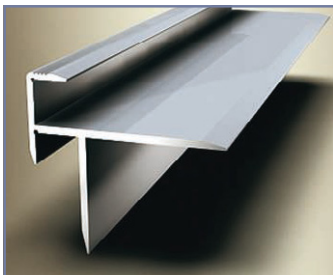

Aluminium stairnose to be screwed. Very resistant to wear & traffic
Ribbed surface for slip-resistance
Elegant finish

- Size:** 40 mm wide x 5 mm inside x 2500 mm long
- Packaging:** Full kit including stairnose profile, screws and dowls.
10 units of 2,5lm in a cardboard box = 25lm
- SAP code:** 1434021 : silver
1434022 : stainless steel

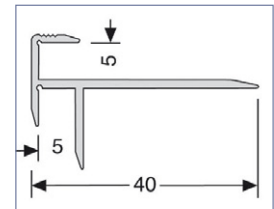

LVT STAIRNOSE VERY HIGH TRAFFIC



Aluminium stairnose for LVT used in very high traffic areas. To be screwed.
Very resistant to very high traffic
Ribbed surface for slip-resistance

- Size:** 38 mm wide x 5/5.5 mm inside x 30 mm high x 2500 mm long
- Packaging:** Full kit including stairnose profiles, screws and dowls. 5 units of 2,5lm in a cardboard box = 12.5 lm
- SAP code:** 1434011: silver
1434012: stainless steel

